



KONICA MINOLTA

**bizhub C751i**



# **bizhub i-SERIES**

**SECURE YOUR RESOURCES  
RETHINK EASE OF USE**



**bizhub i-Series  
A3 Colour Multifunctional Printers**

**C751i**  
Colour 70 PPM  
BW 75 PPM

Giving Shape to Ideas

# SECURE+ SIMPLE



## The new bizhub i-Series secures your business, and is easy to use.

The digital revolution continues to change the way we do business. We require the freedom to readily access data to keep work flowing at the speed business demands. Unfortunately, this can lead to a less secure environment if you're not vigilant. That's why Konica Minolta developed the new bizhub i-Series: to keep you in touch with all of your vital resources in a secure and simple-to-use environment.

From threat notification to proactive security, the new bizhub i-Series is designed to look after your data so you can concentrate on the job at hand with peace of mind. Seamless and productive, the bizhub i-Series has it all.

# Empower your business.

## SECURITY

- Advanced virus protection and reporting
- Proactive security management
- GDPR-ready for privacy standards compliance

## PRODUCTIVITY

- High-speed production and finishing
- Intuitive design for a user-friendly experience
- Supports external applications and remote access

## EFFICIENCY

- High operability with standardised interface
- Remote and predictive maintenance
- Intelligent Media Sensor to prevent downtime



## CUSTOMISE YOUR BUSINESS



A secure and intuitive workplace is what the new bizhub i-Series brings to your business. Thanks to Konica Minolta MarketPlace, you have access to a constantly evolving array of specialised applications to tailor your bizhub MFP to your office work style and needs. Applications on the platform are constantly being upgraded and developed to stay ahead of the dynamic demands of today's business.

# LIFE SHOULD BE SIMPLE

Customise your bizhub i-Series to provide streamlined access to frequently used tasks. The intuitive UI further facilitates efficiency by minimising screen transitions.



## Simply easy

A new, simplified user interface, no hard keys\* and haptic feedback make the operation panel intuitive to users familiar with smart devices. By concentrating on frequently used functions, screen transitions are minimised, making operation easy and convenient.

\*For hard keys, install key pad KP-102.

## 10.1-inch touch panel

Developed for ease of use, the large-size, multi-touch operation panel provides smooth interaction with the new bizhub i-Series. Thanks to smart-tablet-like usability, the panel delivers intuitive operation, enhanced legibility and efficient workflow.



## Customise to optimise

Create folders on the home screen to group functions for ease of use. Increase accessibility for a wider range of users by sorting copy or fax functions into separate folders.

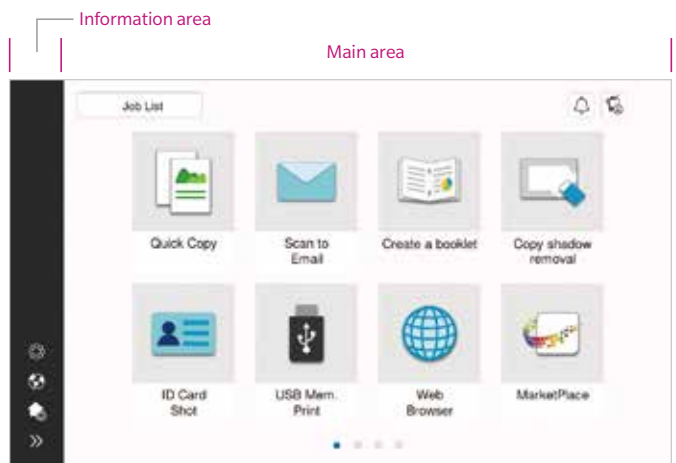

### Quick Copy screen

The Quick Copy screen easily executes the intended task with minimal screen transitions

- Large buttons allow easy browsing and intuitive operation.
- Options are displayed in a list and can be changed with just one touch.

## Choose your style

Switch between two user interface setups to match your office needs. Basic Style features streamlined operation with a customisable choice of intuitive copy functions, while Classic Style displays conventional settings and functions for more advanced needs.

### Home screen

The screen is divided into an Information Area and a Main Area which are customisable.

- Information Area: displays information such as settings menu buttons, ID button, and user name while logged in.
- Main Area: access to functions such as copying, faxing and scanning.

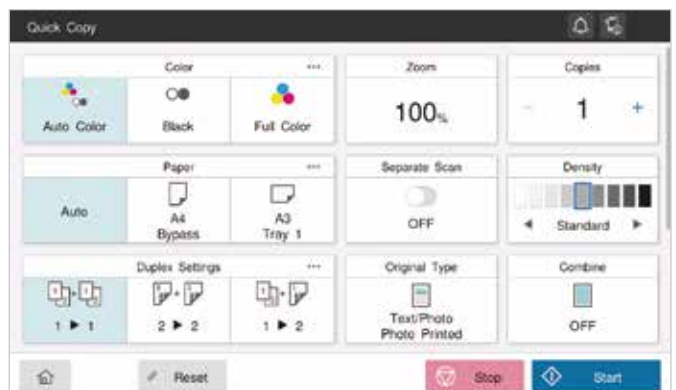



## Made for everyone

Freely adjust the tilt of the new bizhub i-Series operation panel up to 90 degrees to maximise ease of use for every user.



## Functions that simplify jobs

Convenient functions like ID Card Shot are easy to access and even easier to use. Scan both sides and consolidate double-sided documents such as IDs onto a single sheet in just a few easy steps.



## Make a booklet like a pro

Simple-to-follow steps guide you through the process of creating a booklet, such as a corporate profile or in-house magazine.

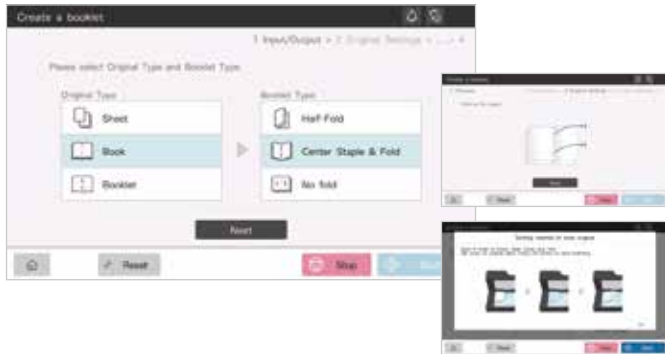

## Smarter functions save you time

When you copy or scan a document with the cover open, smart functions like Non-image Area Erase automatically remove shadows from copies of thick documents such as books.

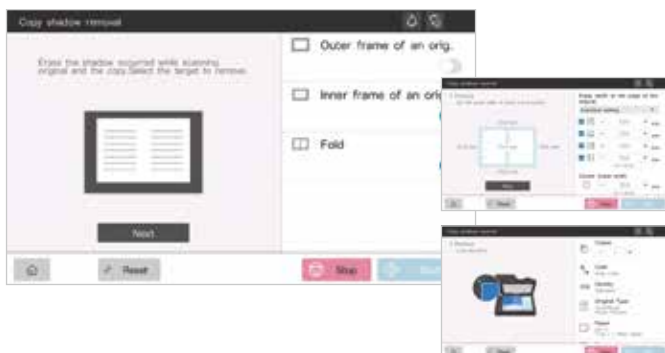

## Indicator lights

LED lights on the front of the new bizhub i-Series indicate data transmission and remind users to pick up their printed documents while gently harmonizing with the office environment.



### Blue LED

Flashing: receiving data  
Lit: processing data

### Orange LED

Flashing: low paper supply  
Lit: empty tray

## A voice to guide you

Voice guidance reads aloud fax numbers and describes major functions, keys and key-related operation to facilitate usability.

Available only in enlarged display mode on copy, fax and scan screens. Requires i-Option LK-104-v3, key pad KP-102 and device connection I/F kit EK-608 or EK-609.

## Be mobile and productive

Install the bizhub Remote Access app on Android or iOS devices connected to the same network as your bizhub i-Series to access an interface similar to the one on the operation panel. Enjoy MFP functions remotely without needing to interact with the operation panel or be standing in front of the MFP.

bizhub Remote Access is available on Google Play and App Store for free. The MFP operation panel cannot be used when bizhub Remote Access is in use.



## Touch panel that's sensitive to your needs

The panel can be operated while wearing gloves, greatly reducing the risk of passing germs or infections in the office via hands or fingers. This feature is handy for environments where gloves are often worn, such as spas or salons.

# START WITH THE BASICS

## | COPY & PRINT |

Equipped with advanced features that revolutionise workflow and productivity, the new bizhub i-Series takes its roots seriously. Sure it can serve as an IoT device, but it's also a powerful performer for copy and print work.



### Ready when you are

The new bizhub i-Series is fast and always ready to help you out. Warm-up time is less than 14 seconds for all of the i-Series MFPs. First Copy Out Time, the time it takes to output the first print, and panel reset time are also speedy to keep you productive.

	C751i	C651i	C551i	C451i	C361i	C301i	C251i
First Copy Out Time (for colour)	3.8 seconds or less	3.8 seconds or less	4.3 seconds or less	5.0 seconds or less	6.1 seconds or less	6.7 seconds or less	6.9 seconds or less
First Copy Out Time (for monochrome)	2.8 seconds or less	2.8 seconds or less	3.3 seconds or less	3.8 seconds or less	4.6 seconds or less	5.0 seconds or less	5.2 seconds or less
Warm-up time (for colour)	14 seconds or less	13 seconds or less	13 seconds or less	13 seconds or less	11 seconds or less	11 seconds or less	11 seconds or less
Warm-up time (for monochrome)	13 seconds or less	12 seconds or less	12 seconds or less	12 seconds or less	11 seconds or less	11 seconds or less	11 seconds or less
Panel reset time	About 1.2 seconds						

### Memory colour to match your imagination

Printer driver settings on the new bizhub i-Series colour match using memory colours by default. Memory colour has higher brightness and saturation, better reflecting the images people have in mind. Konica Minolta's colour matching improves satisfaction with print quality by appealing to people's colour memories.



Conventional method



C751i

### High-quality output

Print at 1,200 dpi resolution for excellent reproduction of small font sizes and detailed design. Outstanding resolution capabilities ensure enhanced legibility of documents and sharp reproduction of fine lines.

Printing at 1,200 dpi slows printing speed.

### Easy-to-use paper trays

The lightweight paper trays on the new bizhub i-Series open and close smoothly with a light press or pull motion. Moreover, in the case of a paper jam, the paper trays can be easily removed to fix the jam.



### Custom-size paper is just as easy

All of the new bizhub i-Series MFPs offer standard compatibility for custom-size paper on two front-loading paper trays. Universal Tray 1 can hold up to 200 post cards or 70 envelopes for easy printing without having to use the side-loading manual feed tray, saving space and increasing efficiency. Universal Paper Tray 2 can handle paper sizes from A5 to SRA3.

### Automatic copy area detection

Non-standard-size documents placed on the platen glass or in the ADF are automatically measured and the size can be registered and saved for future use. This function is ideal for businesses that constantly handle odd-size documents such as tickets or vouchers.

### Non-image Area Erase

Often times, making copies from odd-size or thick materials can produce unwanted shadows on the outside of the image. Non-image Area Erase automatically detects the document area and eliminates the shadow or dark areas surrounding the image. This is ideal for scanning receipts and multiple pages from thick books with the document cover open.

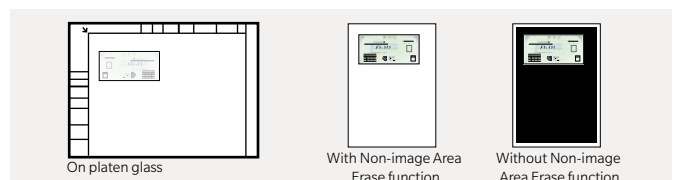

On platen glass

With Non-image Area Erase function

Without Non-image Area Erase function

## Banner printing

The new bizhub i-Series MFPs can easily take over various printing operations that previously had to be outsourced, such as POS materials or banners. Supports extra-long printing up to 1,200 mm and paper widths from 90 mm to 297 mm.

MK-730 Banner Print Guide is recommended.

## Print from the in-panel web browser

Websites can be displayed on the operation panel and printed directly. Specify pages of web-hosted PDF files to print out only what you need. Convenient for quickly printing maps or company contacts before heading to an appointment.



## Print directly from USB

A standard USB port is located to the right of the new bizhub i-Series operation panel. When a USB memory device is inserted, options will automatically appear on the operation panel, allowing you to print directly or save items to the MFP's Box in a few easy steps.

Some USB devices may not be supported. Supported file formats: PDF, compact PDF, JPEG, TIFF, XPS, compact XPS, OOXML (.docx, .xlsx, .pptx).



## Email RX Print

Print files by attaching them to an email and sending to your MFP's email address.

Supported file formats: PDF, compact PDF, JPEG, TIFF, XPS, compact XPS, OOXML (.docx, .xlsx, .pptx). Requires i-Option LK-110 v2.

## Security with Virtual LAN (VLAN) compatibility

Connect to multiple VLAN networks to keep data isolated between networks, without affecting usability. Ideal for offices that secure client's critical data, or for businesses with internal and external networks, company-only and guest networks or shared offices where MFPs are used by multiple groups.

For more details contact your authorized Konica Minolta retailer.

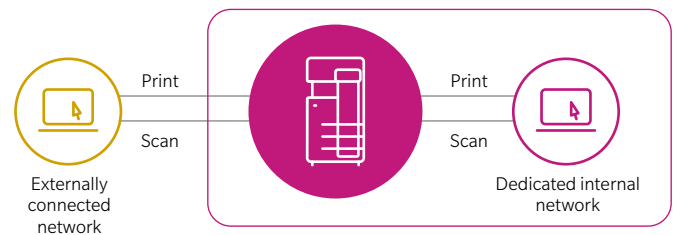

## Other copy functions

- Image Quality Mode to match the original (text, text/photo, photo, faint original, map, copied original)
- Output Mode that matches application (double-sided printing, page aggregation, repeating, grouping, sorting, shifting, booklets, binding margin)
- Diverse Original Document Scan Modes (continuous scan, mixed originals, binding margin, original loading direction, thin paper, Z folded original, dust reduction mode, programmed jobs, blank original removal)
- Copy Mode can be set according to objective (book original, consecutive page copying, index originals, catalogue originals)
- Selectable Layout Adjustment (enlarge/reduce, consecutive enlargement copying, image storage method, mirror imaging, image shift, auto image rotation)
- Page Insertion is handy for adding a coversheet, OHP film, insert sheet, chapter separator, insertion page, among others
- Image Additions allows you to easily add date/time, page number, stamp, watermark, head/footer, overlay or registered overlay
- Frame Erase & Erase Outside detect and copy only what you need
- Copy Security functions include Copy Protect, Repeat Stamp, Copy Guard\*, Password copy\*

\*Requires optional Security Kit SC-509.

## Other print functions

- Supports BMLinkS which connects seamlessly with office equipment
- My Tab Function customises your tab with frequently used settings
- Printing to Tab Paper (index paper)
- Carbon Copy Mode prints the original document and copy at the same time. Different coloured sheets can be loaded to various paper trays if necessary
- Capable of printing on SRA3 size which fits A3 layouts with trim marks
- Auto Trapping Function prints so that there is no white gap around images
- Optional Fiery image controller is supported with professional graphics use

Some functions are only available in Classic Mode.

# DATA IS DATA

## SCAN & FAX

Regardless of where it came from or how you got it, you need to be able to manipulate, send and save documents. High performance scan and fax functions are complemented with a host of tools to improve work efficacy.



### Double your scanning performance

The new bizhub i-Series features a standard\* Dual Scan Document Feeder (DSDF) that simultaneously scans both sides of each sheet, achieving speeds of up to 280 ipm, or 140 double-sided sheets per minute. Load up to 300 sheets at a time, reducing time and effort digitising documents. Automatic skew correction has been improved, correcting the angle of scanned documents to match the original and deliver more accurate scans with less skew.

\*Available with optional DF-714 for C361i, C301i, C251i.



### Multi-feed detection sensors

Ultrasonic waves detect air between pages feeding into the DSDF\*. When an accidental multi-feed is detected, a preview of the scan is shown on the operation panel so the job can be restarted without restarting the job from the beginning.

\*Available with optional DF-714 for C361i, C301i, C251i.

### Easy sort & store for fax data

Received faxes can be sorted according to TSI (Transmitting Subscriber Identification) and stored digitally in the Box. Set automatic transfer to PC or email addresses or forward to the MFP's SMB shared folder to save time and effort distributing received documents. Make paperless operation easy with improved sorting and forwarding options.

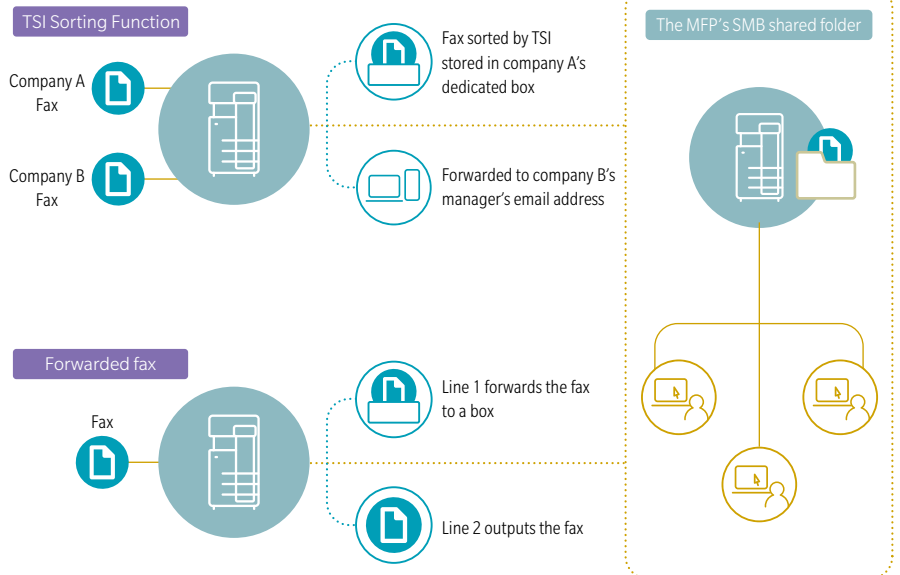

### Easily manage faxes without printing

The Compulsory Memory Receive Box allows users to view faxes on the operation panel to manually select for transfer, printing or deletion, helping to reduce unnecessary output. It can be accessed directly from the home screen.

Requires i-Option LK-110 v2.

### Removal of blank pages

The document feeder detects blank pages as you scan and removes them from the input data, saving you time in manual collating.

### Handle big data with ease

The new bizhub i-Series can scan data and send an access URL to recipients via email. Scan to URL makes it easy to share large-size data which cannot be sent as email attachments, directly from the MFP.

Requires EM-908 Solid State Drive.



## Send data directly to your email

Send scan data to your email inbox using Scan to Me directly from the home screen. And for enhanced protection, activate the authentication setting for secure transmission.

## Efficient format conversion

Scanned originals can be converted into a variety of formats according to what you need them for. Save them to the new bizhub i-Series MFP's Box, a USB memory device, send to a PC or server by email, save to the SMB shared, FTP or Web DAV.

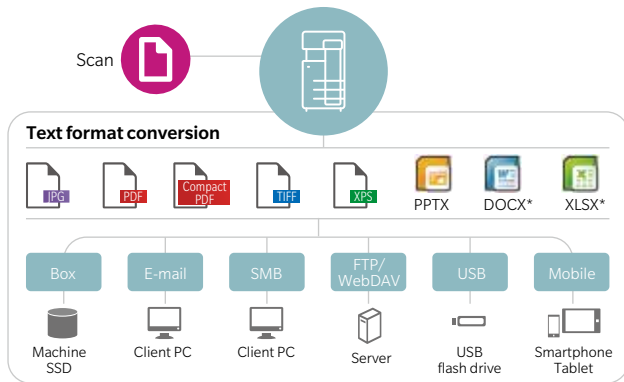

\*Requires i-Option LK-110 v2.

## Digitise paper documents

Scan and convert to PDF and OOXML formats. Ensure your digitised documents are suitable for their intended use by select the file format to best suit your needs.

### Scan to PDF / Scan to OOXML image (with LK-110 v2 installed)

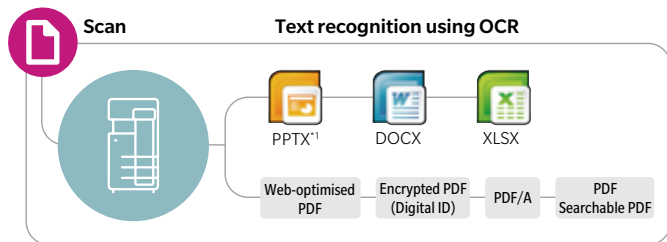

- Applying OCR to a document produces searchable text
- Microsoft Office, etc. enables reuse of images and text.

### File conversion formats

	LK-105 v4	LK-110 v2
	Optional	Optional
PDF/A (long-term archiving)		✓
Web-optimised PDF (linearised PDF)		✓
Encrypted PDF (digital ID)		✓
Searchable PDF (OCR)	✓	✓
OOXML file (extension: docx/.xlsx/.pptx) conversion		✓ <sup>*1</sup>
OOXML file (extension: docx/.xlsx/.pptx) conversion +OCR	✓ <sup>*2</sup>	✓

<sup>\*1</sup> pptx conversion is a standard function, but the OCR function requires either LK-105 v4 or LK-110 v2.  
<sup>\*2</sup> Only compatible with pptx.

## ID Card Scan

Scan and send double-sided documents such as an business cards, ID cards or driver's licences with both sides of the document combined in a single file or separated into different files.

## Other main scan and fax functions

- Super G3 Standard achieves high-speed sending of approx. 2 seconds
- Direct Fax, paperless sending from a PC
- Convert received data into a Searchable PDF format\*  
 \*Requires i-Option LK-110 v2.
- Maximum 2-phone line Fax Function can aggregate multiple faxes
- W-NET FAX compatibility for broad Internet fax interchangeability
- IP Address Fax (T.38 FAX) reduces transmission costs\*  
 \*Requires i-Options LK-117 and FK-514.
- Address Storage for a maximum of 2,000 addresses (100 groups)
- Banner Scan scans long originals from the ADF

## Cost Accounting & Recovery Tools Sold separately

### Dispatcher Paragon



Provides a precise overview of all printing operations within your organisation for smart central accounting which maintains document security. Manage print costs by assigning role and department print quotas and assign codes to individual projects for accurate reporting of costs for your billing convenience. Control your environmental impact by assigning print budgets and enhance your digital workflow by adding optional intelligent scanning to cloud services including Dropbox, Box, Microsoft OneDrive for Business and Microsoft SharePoint Online, directly from the new bizhub i-Series control panel.

## Task Automation Tools Sold separately

### Dispatcher Phoenix



Dispatcher Phoenix automates digitised document processes from file aggregation to processing and distribution. By dividing processes via pre-set conditions, such as OCR processing, file renaming and barcode scanning, each document is automatically stored at a destination. This delivers one-touch execution of cumbersome tasks. Start times can be scheduled so that digitised tasks can be executed quickly and efficiently. Broad scalability and versatility, including connectivity with cloud services, enables creation of flexible workflows tailored to your business and office environment.

Some functions are only available in Classic Mode.

# BETTER SAFE THAN SORRY

Our approach to security is proactive, preventing leaks and addressing security for both digital and paper documents. More importantly, we provide secure access and peace of mind without placing undue burden on your IT department.



## Prioritising security

Nowadays, data protection is a major issue for any company. The new bizhub i-Series delivers advanced security settings through bizhub SECURE, a comprehensive range of services that provide greater protection for customer data stored in the SSD and the MFP's network settings.

## Secure Print

Set a password when you send a document to print via the print driver. The protected document will not print and will be held securely at MFP until the correct password is entered on the operation panel. This feature is useful for confidential documents or when you want to give a limited group of users permission to receive copies.

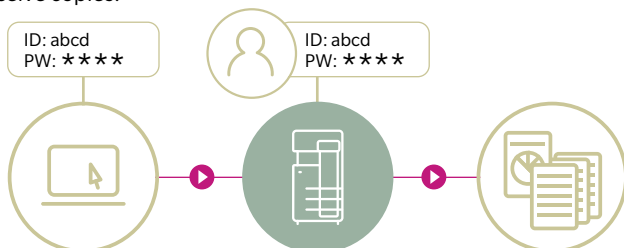

## Secure printing using PC login ID

PC login profiles can be used as ID for secure printing. Users can output secure print jobs quickly and easily without needing to input their username and password at the machine each time.

## Output tray light

A white LED light illuminates the output tray when documents have finished printing to remind users to collect their printed materials. This minimises the risk of forgotten documents and information leaks.



## Encrypted SSD

Equipped with 256 GB, the SSD storage offers heightened security with excellent device compatibility and full-time encryption, maintaining a high level of protection.

## Multiple ways to authenticate users

User authentication can be customized to best suit your office's scale and pre-existing systems. As well as multiple authentication options for every-day users, single sign-on (SSO) is also supported for enhanced operability without sacrificing security.

### Main unit authentication

The new bizhub i-Series allows you to setup authentication using a username and password on the main unit. Set detailed usage restrictions including copy, print, scan and fax.\*

\*Requires FK-514 Fax Kit.

### IC card authentication

Add the optional IC authentication device to add an additional layer of security with non-contact IC cards such as FeliCa. The device supports SSFC (Shared Security Formats Cooperation) specifications which enable integration of wider staff authentication systems with the new bizhub i-Series. Besides IC cards, authentication is possible using NFC-equipped Android devices registered with MFP via the Konica Minolta Mobile Print app.



Non-contact IC cards are compatible with FeliCa (IDm), SSFC, FCF, FCF (Campus) and MIFARE (UID).

### Biometric authentication

If you prefer to avoid having to issue and replace IC cards, Biometric Authentication Device AU-102 is the choice for you. The device uses highly accurate registration of finger veins for quick and easy authentication that supports high-level security systems.

Requires AU-102 Authentication Device and WT-506 Working Table.

## Security you can see

A virus scan icon has been added to the new bizhub i-Series home screen and other panel screens to show when virus scan is enabled. Additionally, you will now be notified via icon changes when a virus is detected or when a pattern file update fails. Use the MFP with greater peace of mind with the virus scan icon visible. Visibility also encourages prompt confirmation when viruses are detected or pattern file updates fail.

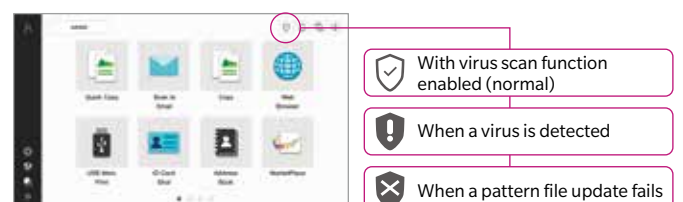

## Virus scan powered by Bitdefender

Protect your network from threats with virus scanning that covers all data exchanged between the new bizhub i-Series and the external environment, including connections to PCs and mobile or USB devices. Periodic scans can also be scheduled or triggered when needed, covering the MFP's Box, SMB shared folder and SSD. Powered by Bitdefender, the pattern file is updated immediately upon powering up and checked every four hours. A virus scan icon on the home screen keeps users informed of the scan status.

Requires i-Option LK-116 and an internet environment.

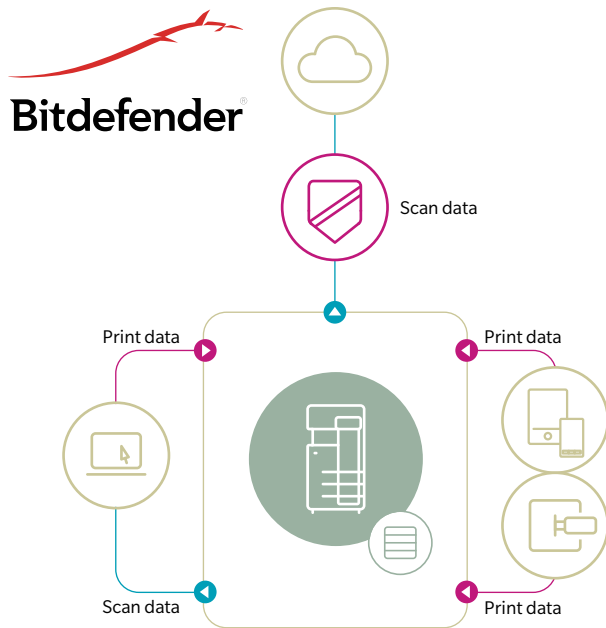

## Stronger network security

The more powerful wireless LAN module features Wi-Fi WPA3 for increased security. TLS1.3 compatibility enables high-speed communication with reduced risk. The module also supports enhanced security for cloud connectivity.



## Serverless printing in a ubiquitous network

Output print jobs from any bizhub MFP on your network after authentication. As a base unit for printing, your new bizhub i-Series works as a print server, enabling a low-cost, serverless printing system for up to 100 MFPs.

Requires i-Option LK-114 for all MFPs.

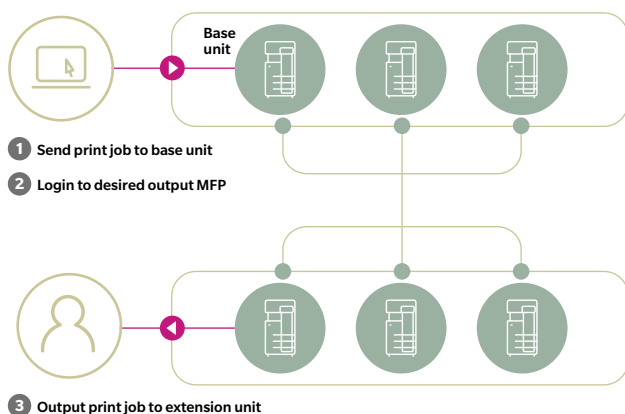

## Security watermark

In addition to Copy Protect, Copy Guard, and Password Copy, you can print with a specialised security watermark embedded into documents which prevents secondary copying and leakage of confidential documents by unauthorized copying.

Requires SC-509 Security Kit. This function is only available in models equipped with Konica Minolta's security watermark function.

## PDF Encryption

### • Password

Encrypt PDFs with a password before distribution.

### • Digital ID

Only authorised recipients with a private key can decrypt. This is more robust than previous public key systems.

When using Digital ID encryption, the email address (S/MIME send) to which the Digital ID has already been registered must be registered to the MFP's abbreviated address.

### • Electronic signature

Electronic signatures certify the author of a document output from the new bizhub i-Series, guaranteeing the document has not been altered and is valid. Third party certifications can also be used.

When using electronic signatures, files should also be encrypted used with password or Digital ID.

## High-level ISO/IEC 15408 compliance

The new bizhub i-Series complies with the Common Criteria for Information Technology Security Evaluation (ISO/IEC 15408). Konica Minolta is in the process of acquiring third-party certification from the Japan-based Information-technology Promotion Agency (IAP). IAP's HDC-PP v1.0 standard certifies that all equipment meets the latest requirements for security.

Information security-related certification obtained for this product (and this system) demonstrates compliance with certification requirements as a result of evaluations based on specified evaluation standards and methods, but does not assure that the product (or the system) is completely without weaknesses.

## Other major security features

- SMTP authentication/POP before SMTP authentication enable security to be set when sending emails.
- SSL/TLS protocol enables encryption of data transmission between networks
- Storage Lock Password prevents unauthorised access to the SSD
- TPM (Trusted Platform Module) safely manages confidential information\*

\*Requires i-option LK-115v2.

### FASEC 1-compliant fax security

- Double Address Input prevents erroneous transmission through input error
- Destination Number Confirmation Display prevents erroneous transmission due to incorrect dialling
- Dial Tone Detection function prevents erroneous transmission due to call collision
- Memory Receive & PC Forward prevents paper faxes from being left behind
- Transmission Result Report and Operation Panel Result Check enables verification of fax transmission

### Konica Minolta's original fax security

- Send Approval Password function prevents erroneous transmission through thorough checking
- Recipient Confirmation (CSI matching) Send prevents erroneous transmission through wrong connection
- Voice Guidance when Sending reads out fax number before sending fax to prevent transmission\*

\*Requires i-Option LK-104v3, Key pad KP-102 and device connection EK-608 / EK-609.

- Designated Tray Paper Feed assists security management

# WORK SMARTER, FINISH FASTER

A score of options to fit the needs of your business allow you to choose just the amount of output and finishing power you demand. Functions like the Intelligent Media Sensor reduce downtime and minimise waste.



## As much paper as you need

The new bizhub C751i boasts a 3,650-sheet paper capacity with the standard paper trays and the manual feed tray. Other models have a standard capacity of 1,150 sheets. Add optional cabinets or large capacity units such as the PC-417 and LU-303 to boost paper capacity of all models to a maximum of 6,650 sheets of 80 g/m<sup>2</sup> paper or an impressive 7,615 sheets of 64 g/m<sup>2</sup> paper.

## Paper Feed Cabinet

The PC-417 Paper Feed Cabinet comprises two large-capacity paper feed trays for A4 and B5 paper. Bringing the total number of front-loading paper feed trays to four, the cabinet supports continuous printing without the need to stop print jobs to replenish paper.

PC-417 is standard for the C751i and optional for the C651i, C551i, C451i, C361i, C301i, C251i.



**Max. 6,650 sheets**  
80 g/m<sup>2</sup>

Multi manual feed (Standard)  
Max. A3  
150 sheets

Universal tray (Standard)  
Max. A3  
500 sheets

Universal tray (Standard)  
Max. SRA3  
500 sheets

PC-417 (Standard for the C751i, optional for the C651i, C551i, C451i, C361i, C301i, C251i)  
Max. A4 2,500 sheets

LU-205 (Option. Compatible with the C751i only.)  
Max. SRA3  
2,500 sheets

LU-303 (Option. Compatible with the C751i only.)  
Max. A4  
3,000 sheets

**Max. 6,650 sheets**  
80 g/m<sup>2</sup>



Universal tray (Standard)  
Max. A3  
500 sheets

Universal tray (Standard)  
Max. SRA3  
500 sheets

Multi manual feed (Standard)  
Max. A3  
150 sheets

LU-207 (Option. Compatible with the C651i, C551i and C451i only.)  
2,500 sheets

LU-302 (Option. Compatible with the C651i, C551i, C451i, C361i, C301i, C251i only.)  
Max. A4  
3,000 sheets

Options



**Max. 3,650 sheets**  
PC-417 (standard for C751i, optional for C651i, C551i, C451i, C361i, C301i, C251i)  
Max. A4 2,500 sheets

**Max. 1,650 sheets**



PC-116 (Option)  
Max. A3  
500 sheets

**Max. 2,150 sheets**



PC-216 (Option)  
Max. A3  
2 x 500 sheets

**Max. 3,650 sheets**



PC-416 (Option)  
Max. A4  
2,500 sheets

All paper volumes calculated using 80 g/m<sup>2</sup> paper unless otherwise indicated.



## Automated to help you

With the new bizhub i-Series, paper type and size are detected and settings are automatically adjusted for optimised printing on various media types, including envelopes. The Intelligent Media Sensor prevents drops in print quality and reduces the burden on users to select the appropriate settings for new paper types and sizes.

IM-103 Paper Detection (Intelligent Media Sensor) is standard on the bizhub C751i, C651i, C551i, C451i. It is optional on the bizhub C361i, C301i, C251i.

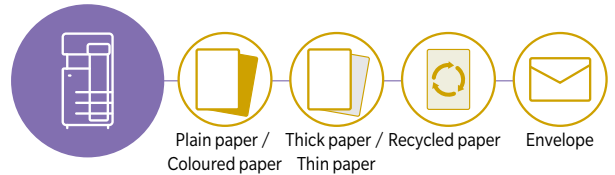

## Manual stapling

Add an optional finisher to your setup to quickly re-staple original documents after copying or for easy stapling when staple settings have not been selected before printing.

FS-539, FS-539SD, FS-540, or FS-540SD  
Finisher option required.



## Smart-size finishing

Capable of handling print speeds up to 55 ppm, the FS-533 inner finisher supports hole punching\*, short-edge parallel corner stapling, and two-point side stapling, without adding to the MFP's footprint. (not available on bizhub C651i and bizhub C751i).

\*Requires punch kit PK-519.

## Offline stapling

FS-P04 is the perfect solution for offices that need basic finishing capabilities but do not want to add a full-size finisher. This compact unit attaches to the optional working table of the new bizhub i-Series to support offline stapling.



Accommodates printing speed up to 55 ppm

Manual stapling up to 50 sheets (23-15/16 lb (90 g/m<sup>2</sup>))

## The choice is yours

Power up the new bizhub i-Series with a range of multifunctional finishers that offer capabilities including booklet making, tri-fold, stapling and hole punching.

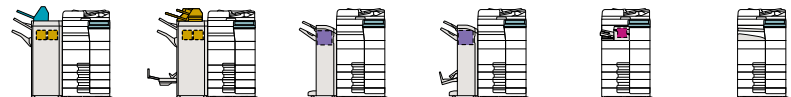

### Finishing Functions

		C751i	C651i	C551i / C451i	C361i / C301i / C251i	FS-540 <sup>*1,*2</sup>	FS-540SD <sup>*1,*2</sup>	FS-539 <sup>*1,*2</sup>	FS-539SD <sup>*1,*2</sup>	FS-533 <sup>*6</sup>	JS-508 / JS-506 <sup>*3</sup>
Compatibility	C751i	✓	✓	✓	✓	✓	✓	✓	✓	—	—
	C651i	✓	✓	✓	✓	✓	✓	✓	✓	—	—
	C551i / C451i	✓	✓	✓	✓	✓	✓	✓	✓	✓	✓
	C361i / C301i / C251i	—	—	✓	✓	✓	✓	✓	✓	✓	✓
Finishing Option		FS-540 <sup>*1,*2</sup>		FS-540SD <sup>*1,*2</sup>		FS-539 <sup>*1,*2</sup>		FS-539SD <sup>*1,*2</sup>		FS-533 <sup>*6</sup>	JS-508 / JS-506 <sup>*3</sup>
Offset sorting (Shift sort) function	Slightly offsets position of each set of pages when discharged	✓		✓		✓		✓		✓	✓
Stapling functions	Corner stapling	✓		✓		✓		✓		✓	—
	Corner stapling (parallel) <sup>*4,*5</sup> Corner stapling (parallel) <sup>*4</sup> Two-point stapling (side)	Thin / Plain (52 - 80 gsm) A4, B5: max. 100 sheets / B4: max. 65 sheets A3, A5: max. 50 sheets Plain (81 - 90 gsm) B4, A4, B5: max. 60 sheets / A3, A5: max. 50 sheets		Thin / Plain (52-90 gsm): max. 50 sheets Plain + / Thick (91-120 gsm): max. 30 sheets Thick (121-209 gsm): max. 15 sheets		Thin / Plain (52 - 90 gsm) A4, B5: max. 50 sheets <sup>*5</sup> A3, B4: max. 30 sheets <sup>*5</sup>		—		—	
Booklet function & folding functions	Saddle stitching  Centre-fold  Tri-fold (up to 3 sheets)	—		Max. 20 sheets		—		Max. 20 sheets		—	
	Z folding function	Z folding	Z folding unit ZU-609 52-90 gsm		—		—		—		—
Hole-punching	Two-hole punch  Upper two-hole punch	Punch kit PK-526 Up to 300 gsm		Punch kit PK-524 Up to 300 gsm		Punch kit PK-519 Up to 157 gsm		—		—	
	Cover sheet & Insert sheet	Cover sheet  Insert sheet	Post Inserter PI-507 <sup>*7</sup> or standard functions		Standard functions		Standard functions		Standard functions		Standard functions
Job separation	Job separation	Job separator JS-602		—		—		—		—	

\*1 Allows setting of a maximum of three output locations. For the FS-540 and FS-540SD, a maximum of four output locations can be set with Job Separator JS-602 installed. \*2 C751i requires Relay Transport Unit RU-519, other models require Relay Transport Unit RU-513 to be installed. \*3 The JS-508 is an option for sorting by function for use on the C551i or C451i. The JS-506 is an option for sorting by function for use on the C361i, C301i or C251i. The sorting function simplifies output of a large number of print jobs. With the JS-506 or JS-508 installed, a finisher cannot be installed. The JS-602 is an option that requires the FS-540 or FS-540SD. \*4 On the FS-540, FS-540SD, FS-539 and FS-539SD parallel stapling is only supported for A3, A4 portrait, A4 landscape, B5 portrait and A5 landscape orientations. Manual setting is required for A3 and A4 landscape. \*5 The FS-533 supports parallel corner stapling only. \*6 Mount kit MK-607 is required when installing FS-533 to bizhub C551i/C451i.

# GO WHERE YOU WANT

Business today is not centred around being at the office all day long. Whether at home or on the move, you are connected to your office and resources, and the new bizhub i-Series is there at your disposal.



## Mobile connectivity

### Connect with NFC-equipped Android devices

The NFC touch area on the front of the bizhub allows users to print from and scan to NFC-equipped Android devices using the Konica Minolta Mobile Print app. After registering the device to your bizhub i-Series using the app, simply hold the device over the NFC touch area to print a selected file. Scanned documents in the MFP can be saved to the device the same way. NFC Android devices can also be used for user authentication, allowing users to log in at the MFP by touching their device.

Wireless LAN environment required.

### Connect with iOS devices

The iOS action button for printing is also supported, making data sharing from a large range of apps smooth and simple. iOS devices can also be used for user authentication, allowing users to log in at the MFP using Bluetooth LE.

Requires EK-609 Local Area Interface Kit and Wireless LAN.

## Secure and simple

Create a local wireless LAN environment with only the new bizhub i-Series, separate from your office LAN, with Simple Access Point (AP) Mode. Bypassing the main office LAN allows secure connection to mobile devices or laptops brought in from outside.

Requires UK-221 Upgrade Kit.

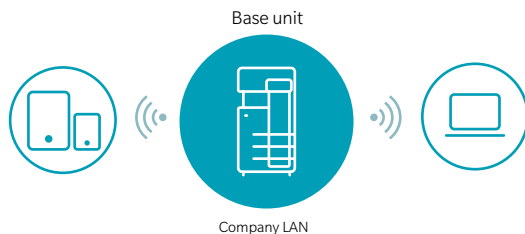

## Scalable to meet your needs

Konica Minolta MarketPlace is pre-installed on the operation panel, giving users access to a wide range of convenient applications to tailor the functionality of the new bizhub i-Series.

## Compatible mobile print services



### Konica Minolta Mobile Print

A simple and intuitive user interface that enables fast, secure connection to mobile devices. Once a mobile device is registered, users can send, receive and share data securely, as well as print documents and images directly from their device. Authentication Print and Secure Print are also supported for worry-free printing of confidential documents.



### AirPrint

Apple's native printing system is supported for iOS and Mac OS devices. Connect to the new bizhub i-Series via wireless LAN without having to install any applications or printer drivers on the device.



### Mopria Print Service & Mopria Scan

Print from and scan to Android devices on your Wi-Fi network using Mopria Alliance apps.

## Worldwide Remote Service Platform

The new bizhub i-Series MFPs feature intelligent self-diagnostic and remote maintenance capabilities. This allows smart prediction of optimum parts and consumables replacement for minimised downtime.

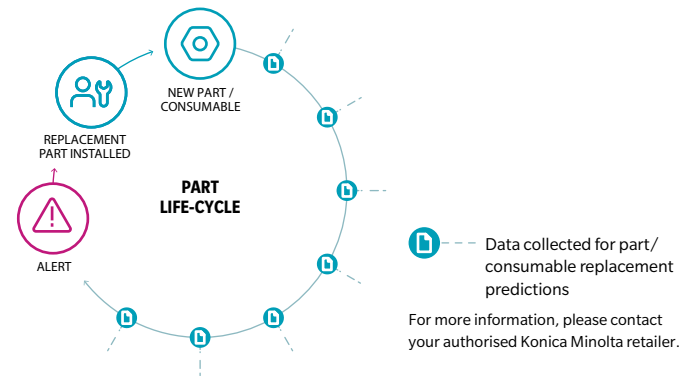

## bizhub Connectors

Connect the new bizhub i-Series directly to selected cloud services<sup>\*1</sup> and SharePoint corporate internal servers using the dedicated Connector app. Authenticate cloud services via the bizhub operation panel to save authentication details and access cloud services with ease.

**bizhub Connector<sup>\*2</sup> offers 3 applications**

**bizhub Connector S-1 for Microsoft SharePoint Server**

**bizhub Connector G-1 for Google Apps**

**bizhub Connector E-1 for Evernote**

\*1 Google Drive, Gmail, and Evernote.

\*2 Requires a separate set-up fee.

# THINK ABOUT IT, WE DO

At Konica Minolta, we are in the business of making business run better. And that's never at the expense of sustainability or environmental responsibility.



## Made responsibly

Konica Minolta's proprietary chemical processing is enhancing the strength and flame resistance of recycled plastics. The new bizhub i-Series is constructed with more than 30% recycled materials, with 88% of the outer casing made from recycled plastic.

## Energy conscious

Power-saving logic on the new bizhub i-Series has been improved, dropping sleep mode power consumption to an industry-leading 0.5 W, reducing environmental impact and total cost of ownership (TCO).

## Sustainability is a priority

Green Products Certification is Konica Minolta's in-house evaluation system for environmental performance and sets a rigorous standard for sustainability and environmental consideration. All MFPs in the new bizhub i-Series have been certified as Green Products.

<https://www.konicaminolta.com/about/csr/environment/activity/solution.html>

## Good Packaging Award

New bizhub i-Series MFPs are delivered protected by award-winning styrofoam Air Cushion packaging materials. Cushions are carefully distributed around the MFP for maximum protection and minimum waste.



## Setting the tone for smart energy use

Konica Minolta's high-performance polymerised Simitri V toner requires less heat for fixing, using a temperature around 15° C lower than previous models, saving energy on every print. Simitri V toner also uses less energy during the manufacturing process.

## Low energy consumption

Energy efficient features on the new bizhub i-Series mean that typical energy consumption (TEC) easily clears the values stipulated in the International Energy Star Program Version 3.0. Improved thermal insulation and a high-efficiency heater prevent heat loss and reduce warm up times for efficient operation and minimised environmental impact.

## 100% renewable energy

Konica Minolta is contributing to reducing global CO<sub>2</sub> by using certified renewable electricity and solar power throughout production. All Konica Minolta Group MFP production facilities use 100% renewable energy. Work is currently under way to expand the use of renewable energy at all sales bases around the world.

## Environmental standards

Konica Minolta products are designed and manufactured in compliance with the leading global environmental standards.



The Blue Angel  
(Germany)



Green Purchase  
(Japan)



Eco Mark (Japan)



RoHS  
対応  
Restriction of Hazardous  
Substances  
(EU)

# PRODUCT SPACE REQUIREMENTS

bizhub C751i standard configuration

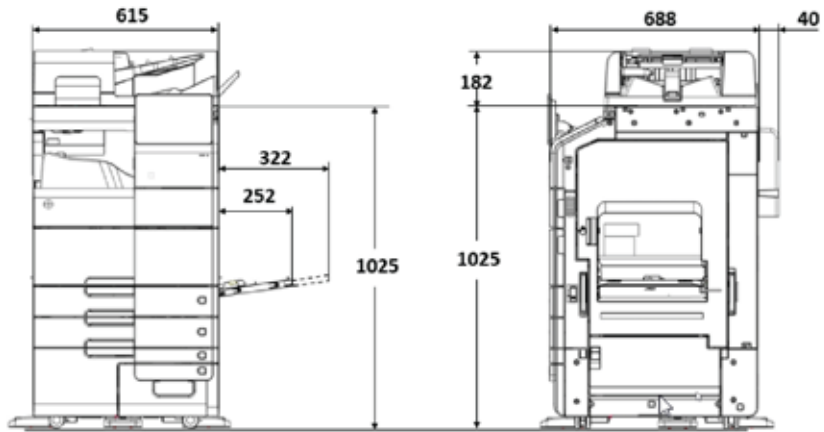

bizhub C751i

FS-539+LU302

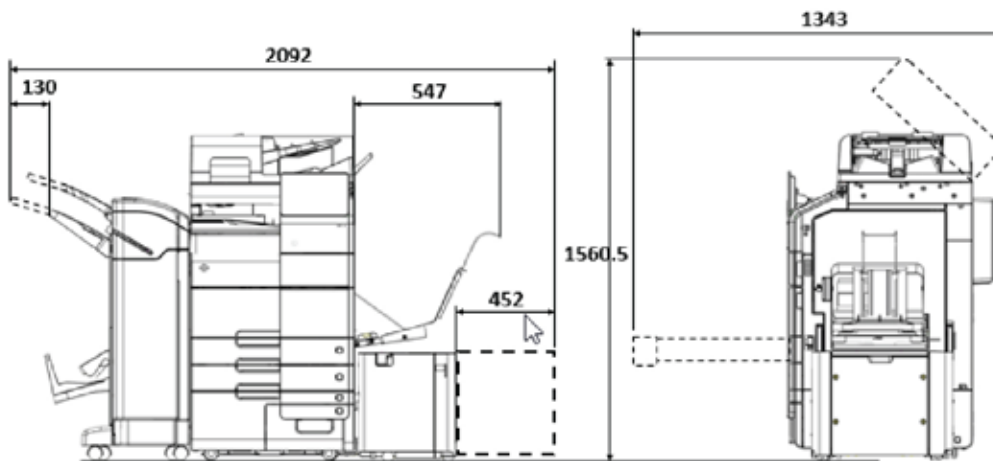

bizhub C751i

LU207+FS-540+JS-602+CU-102

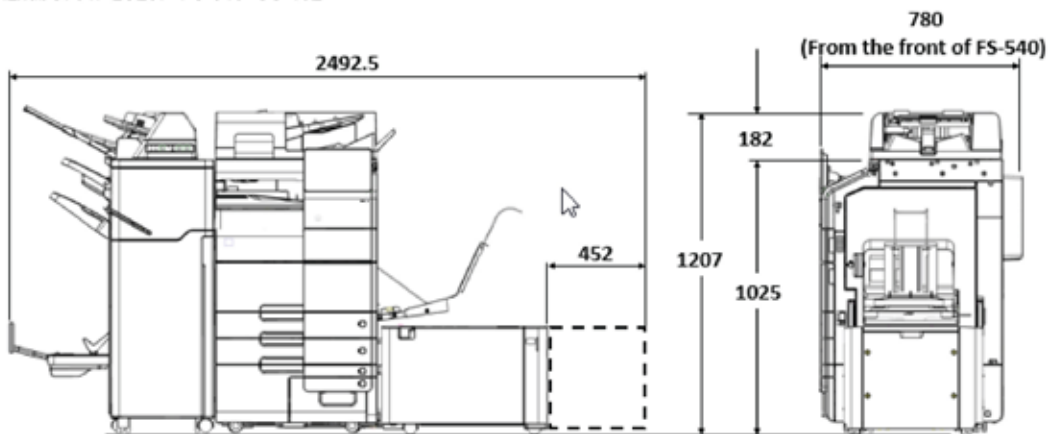



## CUSTOMER BENEFITS



**Intuitive operability**  
Operate the bizhub like a smartphone or tablet with fully customised user interface



**Mobile connectivity**  
Print anytime from anywhere with Konica Minolta's innovative mobile technologies



**Security**  
Secure network integration, data encryption, storage data overwrite, and advanced user authentication



**Application ecosystem**  
Enhanced efficiency thanks to Konica Minolta's extensive applications portfolio



**Productivity**  
Reliability, high-speed scanning and printing, combined with powerful finishing functions



**Sustainability**  
Numerous eco features reduce energy consumption and costs

## OPTIONS

### 1 ENHANCED FEATURES

- Voice guidance  
LK-104v3
- OCR text recognition  
LK-105v4
- Barcode fonts  
LK-106
- Unicode fonts  
LK-107
- OCR A and B fonts  
LK-108
- Document converter pack  
LK-110v2
- ThinPrint® client  
LK-111
- Serverless pull printing  
LK-114
- Trusted Platform Module  
LK-115v2
- Antivirus  
LK-116
- FOIP activation  
LK-117



### 2 CONNECTIVITY

- Fax board  
FK-514 x2
- Wireless LAN  
UK-221
- USB I/F kit  
EK-608
- USB I/F kit with bluetooth  
EK-609 OR
- Fiery controller  
IC-420
- Interface kit for IC-420  
VI-516
- Biometric authentication  
AU-102 OR
- Card authentication  
ID card reader
- Mount kit  
MK-735

### 3 OTHERS

- Upright panel  
WT-519 OR
- Working table  
WT-506 OR
- Offline Stapler  
FS-P04
- 10-Key pad  
KP-102
- Security kit  
SC-509
- Replacement SSD  
EM-908
- Keyboard holder  
KH-102
- Air cleaning unit  
CU-102

### 4 MEDIA INPUT

- Large capacity tray  
LU-303 OR
- Large capacity tray  
LU-205 OR
- Banner tray  
MK-730

### 5 MEDIA OUTPUT

- Output tray  
OT-514 OR
- Staple finisher  
FS-539 OR
- Relay unit  
RU-519 OR
- Booklet finisher  
FS-539SD OR
- Relay unit  
RU-519 OR
- Punch kit for FS-539/SD  
PK-524
- Staple finisher  
FS-540 OR
- Relay unit  
RU-519 OR
- Booklet finisher  
FS-540SD OR
- Relay unit  
RU-519 OR
- Punch kit for FS-540/SD  
PK-526
- Post inserter for FS-540/SD  
PI-507 OR
- Job separator for FS-540/SD  
JS-602 OR
- Z-fold unit for FS-540/SD  
ZU-609

#### LEGEND

- Mandatory option
- Option
- This option can only be installed with the respective option above it

## FINISHING FUNCTIONALITIES



Corner stapling



Two-point stapling



Two-hole punching



Four-hole punching



Duplex



Combined mixplex/mixmedia



Half-fold



Sheet insertion



Letter-fold



Booklet



Offset sorting



Z-fold



Banner printing



Corner Stapling (offline)

## DESCRIPTION

### ENHANCED FEATURES

LK-104v3 Voice guidance	Supports voice guidance
LK-105v4 OCR text recognition	Searchable PDF and PPTX
LK-106 Barcode fonts	Supports native barcode printing
LK-107 Unicode fonts	Supports native Unicode printing
LK-108 OCR A and B fonts	Supports native OCR A and B font printing
LK-110v2 Document converter pack	Generates various file formats incl. DOCX, XLSX and searchable PDF
LK-111 ThinPrint® client	Print data compression for reduced network impact
LK-114 Serverless pull printing	Secure and Follow Me printing solution requiring no server application
LK-115v2 Trusted Platform Module	Trusted Platform Module for protection of data encryption and decryption
LK-116 Antivirus	Bitdefender® antivirus provides real time scanning of all incoming and outgoing data
LK-117 FOIP activation	Fax over IP networks (T.38), requires fax kit

### CONNECTIVITY

FK-514 Fax board	Super G3 fax, digital fax functionality
UK-221 Wireless LAN	Wireless LAN and wireless LAN Access Point Mode
EK-608 USB I/F kit	USB keyboard connection
EK-609 USB I/F kit	USB keyboard connection; Bluetooth
IC-420 Fiery controller	Professional colour print controller
VI-516 Interface kit for IC-420	Fiery controller interface card
AU-102 Biometric authentication	Finger vein scanner
ID card reader	Various ID card technologies
MK-735 Mount kit	Installation kit for ID card reader

### OTHERS

WT-506 Working table	Authentication device and/or offline stapler placement
FS-P04 Offline Stapler	Offline stapler, 20 sheets stapling
WT-519 Upright panel	Working table for upright panel
KP-102 10-Key pad	For use instead of touchscreen
SC-509 Security kit	Copy guard function
EM-908 Replacement SSD	1 TB SSD to increase storage space
KH-102 Keyboard holder	To place USB keyboard
CU-102 Air cleaning unit	Improving indoor air quality by reduced emission

### MEDIA INPUT

LU-303 Large capacity tray	3,000 sheets, A4, 52–256 g/m <sup>2</sup>
LU-205 Large capacity tray	2,500 sheets, A4–SRA3, 52–256 g/m <sup>2</sup>
MK-730 Banner tray	Multipage banner feeding

### MEDIA OUTPUT

OT-514 Output tray	Output tray used instead of finisher
FS-539 Staple finisher	50 sheets stapling; 3,200 sheets max. output
FS-539SD Booklet finisher	50 sheets stapling; 20 sheets booklet finisher; 2,200 sheets max. output
PK-524 Punch kit for FS-539/SD	2/4 hole punching; autoswitching
FS-540 Staple finisher	100 sheets stapling; 3,200 sheets max. output
FS-540SD Booklet finisher	100 sheets stapling; 20 sheets booklet finisher; 2,700 sheets max. output
PK-526 Punch kit for FS-540/SD	2/4 hole punching; autoswitching
RU-519 Relay unit	For FS-539/SD or FS-540/SD installation
PI-507 Post inserter for FS-540/SD	Cover insertion; post finishing
JS-602 Job separator for FS-540/SD	Separation of fax output; etc.
ZU-609 Z-fold unit for FS-540/SD	Z-fold for A3 prints

## TECHNICAL SPECIFICATIONS

### SYSTEM SPECIFICATIONS

System speed A4	Up to 75/70 ppm (mono/colour)
System speed A3	Up to 37/35 ppm (mono/colour)
Autoduplex speed A4	Up to 75/70 ppm (mono/colour)
1st page out time A4	2.8/3.8 sec. (mono/colour)
Warm-up time	Approx. 13/14 sec. (mono/colour) <sup>1</sup>
Imaging technology	Laser
Toner technology	Simitri V toner
Panel size/resolution	10.1" / 1024 x 600
System memory	8,192 MB (standard/max)
System hard drive	256 GB SSD (standard) / 1 TB SSD (optional)
Interface	10/100/1,000-Base-T Ethernet; USB 2.0; Wi-Fi 802.11 b/g/n/ac (optional)
Network protocols	TCP/IP (IPv4 / IPv6); SMB; LPD; IPP; SNMP; HTTP(S); Bonjour
Automatic document feeder	Up to 300 originals; A6-A3; 35-210 g/m <sup>2</sup> ; Dualscan ADF
ADF double feed detection	Standard
Printable paper size	A6-SRA3; customized paper sizes; banner paper max. 1,200 x 297 mm
Printable paper weight	52-300 g/m <sup>2</sup>
Paper input capacity	3,650 sheets / 6,650 sheets (standard/max)
Paper tray input (standard)	1x 500; A6-A3; custom sizes; 52-256 g/m <sup>2</sup> 1x 500; A5-SRA3; custom sizes; 52-256 g/m <sup>2</sup> 1x 1,500; A5-A4; 52-256 g/m <sup>2</sup> 1x 1,000; A5-A4; 52-256 g/m <sup>2</sup>
Large capacity tray (optional)	LU-303 3,000; A4; 52-256 g/m <sup>2</sup> LU-205 2,500; A4-SRA3; custom sizes; 52-256 g/m <sup>2</sup>
Manual bypass	150 sheets; A6-SRA3; custom sizes, banner; 60-300 g/m <sup>2</sup>
Finishing modes (optional)	Offset; Group; Sort; Staple; Staple (offline); Punch; Half-fold; Letter-fold; Booklet; Post insertion; Z-fold

### SYSTEM SPECIFICATIONS

Automatic duplexing	A6-SRA3; 52-256 g/m <sup>2</sup>
Output capacity	Up to 200 sheets / up to 3,300 sheets (standard/max)
Stapling	Max. 100 sheets or 98 sheets + 2 cover sheets (up to 300 g/m <sup>2</sup> )
Stapling output capacity	Max. 200 sets
Letter fold	Max. 3 sheets
Letter fold capacity	Max. 50 sets; unlimited (without tray)
Booklet	Max. 20 sheets or 19 sheets + 1 cover sheet (up to 300 g/m <sup>2</sup> )
Booklet output capacity	Max. 35 booklets; unlimited (without tray)
Duty cycle (monthly)	Rec. 80,000 pages; Max. <sup>2</sup> 300,000 pages
Toner lifetime	Black up to 45,000 pages CMY up to 45,000 pages
Imaging unit lifetime	Black up to 240,000/1,000,000 pages (drum/developer) CMY up to 165,000/1,000,000 pages (drum/developer)
Power consumption	220-240 V / 50/60 Hz; Less than 2.10 kW
System dimension (W x D x H)	615 x 688 x 1207 mm (without options)
System weight	Approx. 160.0 kg (without options)

### PRINTER SPECIFICATIONS

Print resolution	1,800 (equivalent) x 600 dpi; 1200 x 1200 dpi
Page description language	PCL 6 (XL3.0); PCL 5c; PostScript 3 (CPSI 3016); XPS
Operating systems	Windows 10 (32/64); Windows 11; Windows Server 2012; Windows Server 2012 R2; Windows Server 2016; Windows Server 2019; Windows Server 2022; macOS 10.14 or later; Unix; Linux; Citrix
Printer fonts	80 PCL Latin; 137 PostScript 3 Emulation Latin; Optional: Barcode fonts; OCR A and B fonts; Unicode fonts
Mobile printing	AirPrint (iOS); Mopria (Android); Konica Minolta Mobile Print (iOS/Android) optional: WiFi Direct

## PRINTER SPECIFICATIONS (OPTIONAL)

<b>Print controller</b>	Embedded Fiery IC-420 v2
<b>Controller CPU</b>	Intel Celeron G4900T @ 2.9GHz
<b>Memory/HDD</b>	4GB / 500 GB
<b>Page description language</b>	Adobe PostScript 3 (CPSI 3020); PCL 6; PCL 5c
<b>Operating systems</b>	Windows 10 (32/64); Windows Server 2012; Windows Server 2012 R2; Windows Server 2016; Windows Server 2019; Macintosh OSX 10.10 or later; Linux

## SCANNER SPECIFICATIONS

<b>Scan speed</b>	200dpi Up to 140/140 ipm in simplex (mono/colour) Up to 280/280 ipm in duplex (mono/colour) 600dpi Up to 80/75 ipm in simplex (mono/colour) Up to 160/150 ipm in duplex (mono/colour)
<b>Scan resolution</b>	Up to 600 x 600 dpi
<b>Scan modes</b>	Scan-to-eMail (Scan-to-Me); Scan-to-SMB (Scan-to-Home); Scan-to-FTP; Scan-to-Box; Scan-to-USB; Scan-to-WebDAV; Scan-to-DPWS; Scan-to-URL; TWAIN scan
<b>File formats</b>	JPEG; TIFF; PDF; Compact PDF; Encrypted PDF; XPS; Compact XPS; PPTX; PDF/A 1a and 1b optional: Searchable PDF; Searchable DOCX/PPTX/XLSX
<b>Scan destinations</b>	2,000 destinations + 100 groups; LDAP support

## COPIER SPECIFICATIONS

<b>Copy resolution</b>	600 x 600 dpi
<b>Gradation</b>	256 gradations
<b>Multicopy</b>	1-9,999
<b>Original format</b>	Max. A3
<b>Magnification</b>	25-400% in 0.1% steps; Auto-zooming

## FAX SPECIFICATION

<b>Fax standard</b>	Super G3 (optional)
<b>Fax transmission</b>	Analogue; i-Fax; Colour i-Fax; IP-Fax
<b>Fax resolution</b>	Up to 600 x 600 dpi
<b>Fax compression</b>	MH; MR; MMR; JBIG
<b>Fax modem</b>	Up to 33.6 Kbps
<b>Fax destinations</b>	2,000 single + 100 groups

## USER BOX SPECIFICATIONS

<b>Storable documents</b>	Up to 3,000 documents or 10,000 pages
<b>Type of user boxes</b>	Public; Personal (with password or authentication); Group (with authentication)
<b>Type of system boxes</b>	Secure print; Encrypted PDF print; Fax receipt; Fax polling

## SYSTEM FEATURES

<b>Security</b>	ISO15408 Common Criteria (in evaluation); IP filtering and port blocking; TLS1.2/1.3 network communication; IPsec support; IEEE 802.1x support; User authentication; Authentication log; Secure print; Kerberos; Storage data overwrite; Storage data encryption (AES 256); Confidential fax; Print user data encryption optional: Antivirus realtime scanning (Bitdefender®), Copy protection (Copy Guard, Password Copy)
<b>Accounting</b>	Up to 1,000 user accounts; Active Directory support (user name + password + e-mail + smb folder); User function access definition; Authentication by mobile device (Android) optional: Biometric authentication (finger vein scanner); ID card authentication (ID card reader); Authentication by mobile device (iOS)
<b>Software</b>	Data Administrator; Web Connection; HDD Backup Utility; Driver Packaging Utility; Log Management Utility; Font Management Utility; Download Manager

<sup>1</sup> Warm-up time may vary depending on the operating environment and usage

<sup>2</sup> If the maximum volume is reached within a period of one year, then a maintenance cycle must be performed

- All specifications refer to A4-size paper of 80 g/m<sup>2</sup> quality.
- The support and availability of the listed specifications and functionalities varies depending on operating systems, applications and network protocols as well as network and system configurations.
- The stated life expectancy of each consumable is based on specific operating conditions such as page coverage for a particular page size (5% coverage of A4). The actual life of each consumable will vary depending on use and other printing variables including page coverage, page size, media type, continuous or intermittent printing, ambient temperature and humidity.
- Some of the product illustrations contain optional accessories.
- Specifications and accessories are based on the information available at the time of printing and are subject to change without notice.
- Konica Minolta does not warrant that any specifications mentioned will be error-free.
- All brand and product names may be registered trademarks or trademarks of their respective holders and are hereby acknowledged.



#### Konica Minolta Business Solutions Asia Pte Ltd

21 Media Circle  
#08-01 Infinite Studios  
Singapore 138562  
Tel: +65 6563 5533  
Fax: +65 6561 9879  
Email: sales@konicaminolta.sg  
www.konicaminolta.com

#### PRESENCE IN THE REGION

BANGLADESH . BRUNEI . CAMBODIA . INDONESIA . LAOS . MALAYSIA . MAURITIUS . MYANMAR . PHILIPPINES . SINGAPORE . SRI LANKA . THAILAND . VIETNAM

#### About Konica Minolta Business Solutions Asia

Konica Minolta's journey started more than 150 years ago, with a vision to see and do things differently. We innovate for the good of society and the world. The same purpose that kept us moving then, keeps us moving now.

Konica Minolta Business Solutions Asia, based in Singapore, is a wholly owned subsidiary of Konica Minolta Inc., Tokyo, Japan. With its unique expertise in imaging, data processing and data-based decision making, Konica Minolta creates relevant solutions for its customers - small and medium-sized businesses, large enterprises and public sector - and solves issues faced by society.

As a digital workplace solution provider, Konica Minolta helps its clients to identify and unlock the potential digitalisation holds and reach the next level in the digital maturity of their organisation by rethinking the workplace. In support of an 'Intelligent connected workplace', Konica Minolta offers cloud, IT, managed print and video solution services for remote working, collaboration, workflow management and automation and security. The company's success in driving transformation is also confirmed by IDC, since the 'IDC MarketScape: Worldwide Print Transformation 2023 Vendor Assessment' has named Konica Minolta a "Leader" in print transformation. Konica Minolta has been a Microsoft Global Managed Partner since 2021.

The company has been repeatedly recognised for its rich history of social contribution as well as for working towards achieving the SDGs throughout its business and supply chain. Konica Minolta is listed among "2023 Global 100 Most Sustainable Corporations in the World" and received a GOLD Level Recognition Medal in the EcoVadis sustainability ratings for 2023.

Worldwide, the company has over 39,000 employees and is operating in over 150 countries.

For more information, please visit <https://www.konicaminolta.com/>

**Our organisation is certified according to ISO27001, ISO9001 and ISO14001 standards.**



Scan Me for more info !



FOR THE EARTH. FOR THE FUTURE.